

KM-1301SAH-E

STACKABLE ICE CUBER

Item # _____

Project: _____

Qty: _____

*AutoCad available on KCL

KM-1301SAH-E

10/10

Item # 13055

CUBER DIMENSIONS

W x D x H

KM-1301SAH-E
122 x 69.5 x 69.5cm

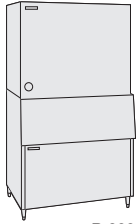

B-800

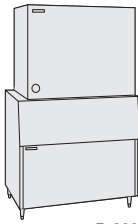

B-900

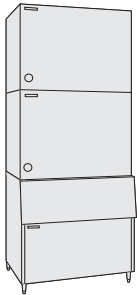

B-800

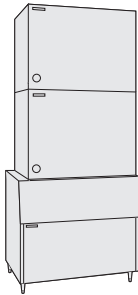



B-900

KM-1301SAH-E

Air-Cooled
Shown on an optional
B-900



Also available on Large Bins:
B-1150SS
B-1300SS

- Up to 505 kgs. of ice production per 24 hours
- Durable stainless steel exterior
- Protected by *HoshiGuard* Antimicrobial Agent 
- CycleSaver® design 
- EverCheck® alert system 
- Individual crescent cube
- Stainless steel evaporator
- Stackable for 1010 kgs. per 24 hour ice production in the same floor space
- Removable air filters
- R-404A Refrigerant



Warranty

Contact factory for warranty information.



Hoshizaki

KM-1301SAH-E STACKABLE ICE CUBER

DIMENSIONS
W x D x H
KM-1301SAH-E
122 x 69.5 x 69.5cm

STACKABLE ICE CUBER

- Air-cooled

AIR - COOLED

Water Temp ° C.	10°	21°	32°	
Air Temp ° C.	21°	505	491	450
	27°	494	471	419
	32°	491	455	407

UTILITY CONSUMPTION at 32°C A/ 21°C W

Model Number	Ice Production Per Cycle		KWH per 45 kgs.	Potable Water Liters per 45 kgs.	Condenser Water Liters per 45 kgs.
	Kgs.	Cubes			
KM-1301SAH-E	13.2	1440	5.1	59.0	N/A

SPECIFICATIONS

Model Number	Condenser	Amperage	Min. Circuit Ampacity	Shipping Weight
KM-1301SAH-E	Air-Cooled	11.8	20	143 kgs.

STORAGE BINS

Model Number	Application Capacity
B-800	363 kgs.
B-900	409 kgs.
B-1150	522 kgs.
B-1300	578 kgs.
B-1500	676 kgs.
B-1650	728 kgs.

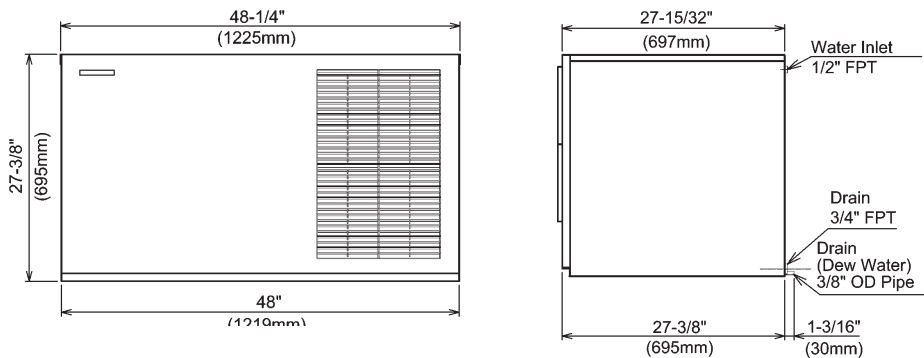

FRONT VIEW

SIDE VIEW

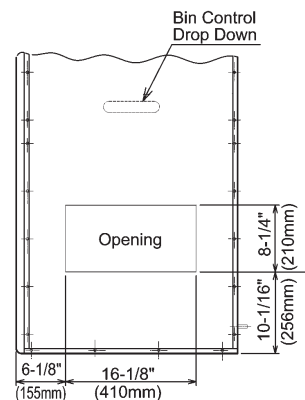

ICE DROP ZONE

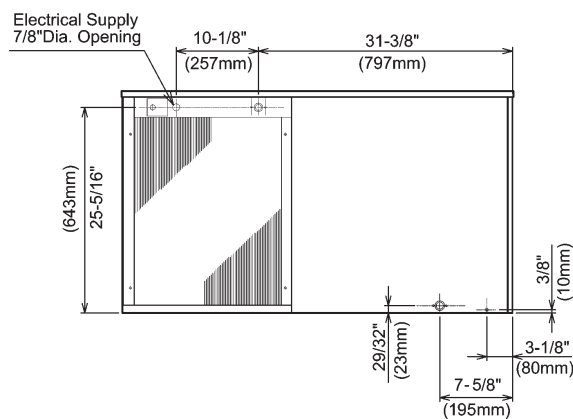

AIR-COOLED UNIT

ELECTRICAL & PLUMBING/KM-1301SAH-E

- 220 - 240V/50/1
- 20 amp Max Fuse
- 1.27cm OD copper or equivalent independent potable water supply
- 3/4" FPT independent drain connection

OPERATING LIMITS

- Ambient Temp Range 7 - 38°C
- Water Temp Range 7 - 32°C
- Water Pressure 0.7 - 8 kg/cm²
- Voltage Range 198 - 254V

SERVICE

- Panels easily removed and all components accessible for service.
- Removable/cleanable air filters.



© HOSHIZAKI AMERICA, INC.

618 Hwy. 74 S., Peachtree City, GA 30269

TEL 1-800-438-6087

FAX 1-800-345-1325

www.hoshizaki.com

Printed in U.S.A.

